

Front

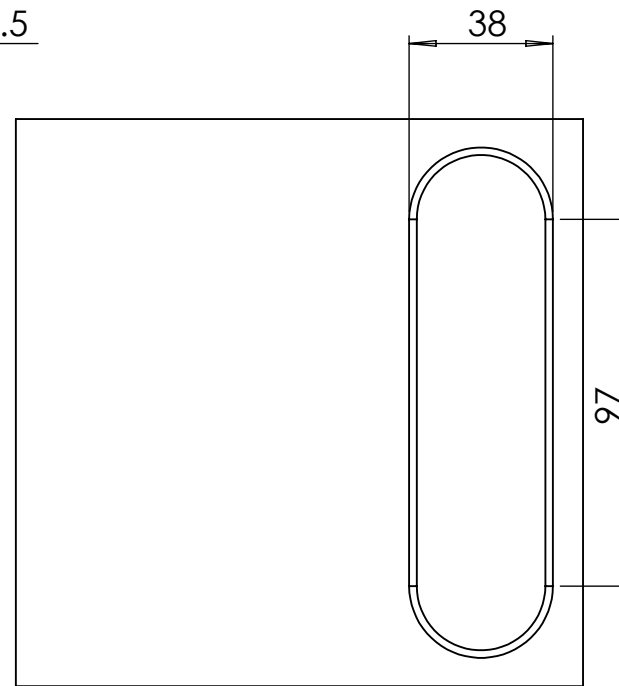

Rear

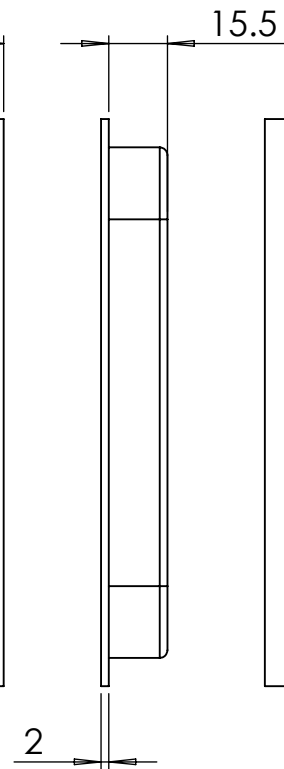
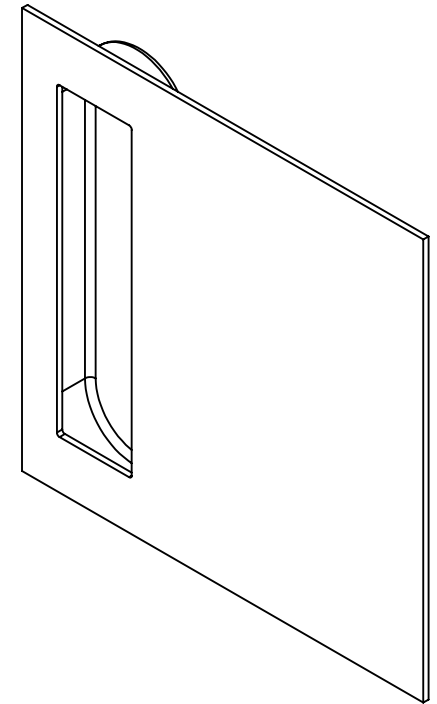

madinoz
ARCHITECTURAL HARDWARE

3/1-7 Ada Avenue BROOKVALE N.S.W 2100
PHONE: + 61 2 9939 2007 FAX: + 61 2 9939 8432

DATE
16/02/2016

MATERIAL:
THICKNESS:
WEIGHT:
FINISH:

UNLESS OTHERWISE SPECIFIED:
DIMENSIONS ARE IN MILLIMETERS

DEBUR AND BREAK SHARP
EDGES

THIRD ANGLE PROJECTION

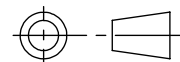

SCALE: 1:2 SHEET 1 OF 1

COPYRIGHT

DRAWING #: MDZ FP170

A4